

TOTO LINK
The Smartest Network Device

Quick Installation Guide

AC2100 Wireless Dual Band Gigabit Router

Model No.: A6000R

Copyrights © TOTOLINK. All Rights Reserved. Website: <http://www.totolink.net>
Information in this document is subject to change without prior notice.

1 Installation Diagram

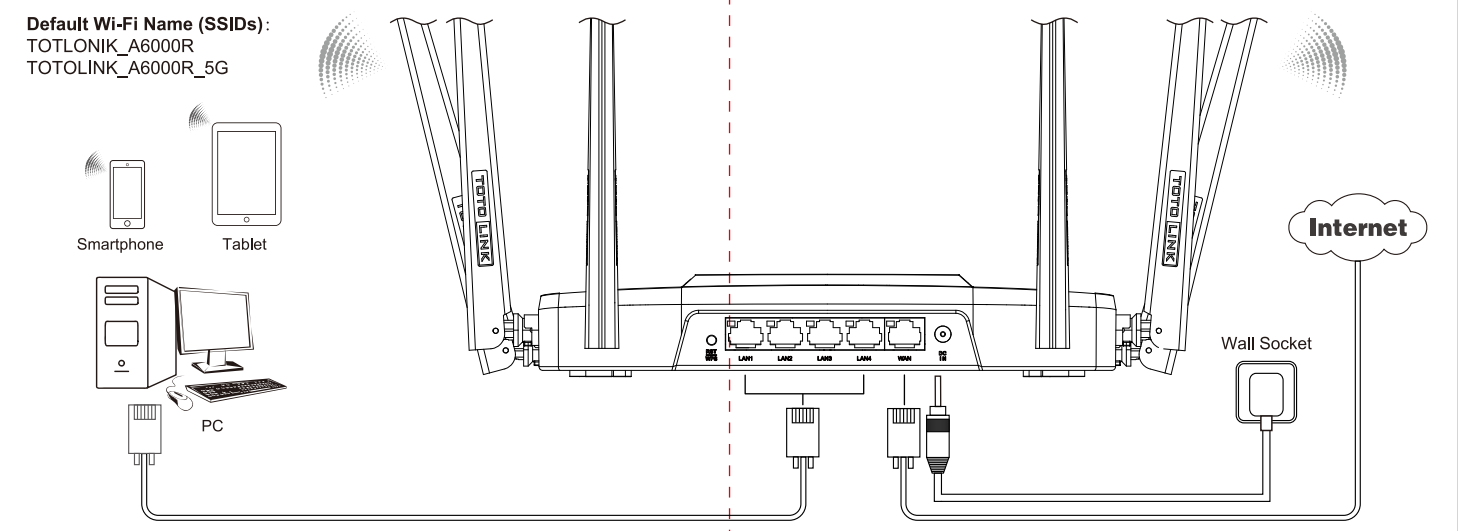

LEDs, Ports, Buttons

System indicator	On	Power on.
	Off	Power off.
	Blinking every one second	Router is working normally.
	Blinking quickly solid on for two minutes	The router is being reset, ready to reboot. WPS function is activating.
WAN/LAN indicator	On	Port connected.
	Off	Port disconnected.
	Blinking	The connected port is transmitting data.

DC Power Port	Connect to the power supply.
WAN Port	Connect to the Internet.
LAN 1/4 Ports	Connect to PCs.
RST/WPS Button	Activate WPS function: when the router is powered on, press and hold the button for 1 second, the System indicator keeps solid on for 2 minutes. Reset to factory defaults: when the router is powered on, press and hold this button for 5 seconds or more until the System indicator blinks quickly.

2 Configure the Router on Phone

- 1 Activate the WLAN function on your Phone and connect to TOTOLINK_A6000R_5G or TOTOLINK_A6000R. Then run any Web browser and enter <http://itotolink.net> in the address bar.(P1)
- 2 Enter **admin** for the password and then click **LOGIN**.(P2)
- 3 Time Zone setting. According to your location, please click the Time Zone to choose a correct one from the list, then click **Next**.(P3)
- 4 Internet Setting. Choose a suitable connection type from the list and fill in the information required, then click **Next**.(P4/P5/P6)

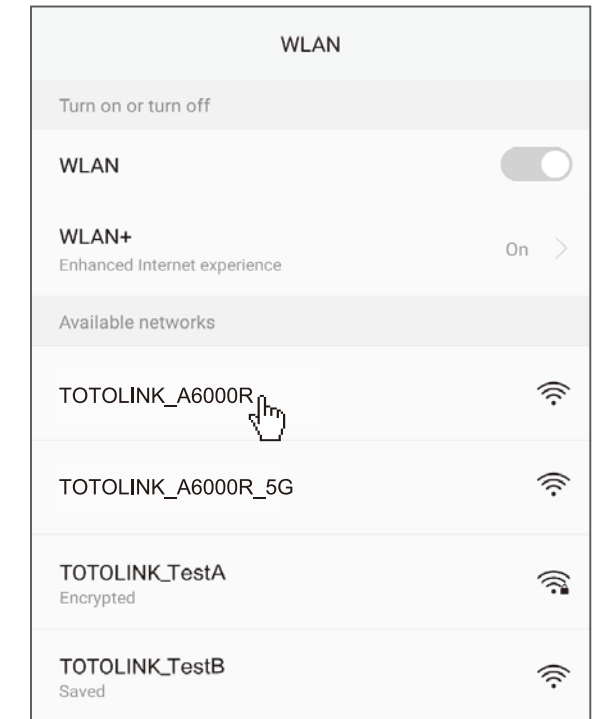

(P1)

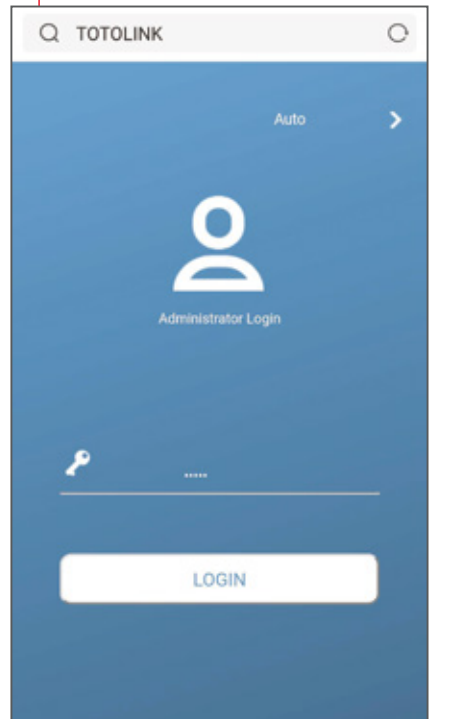

(P2)

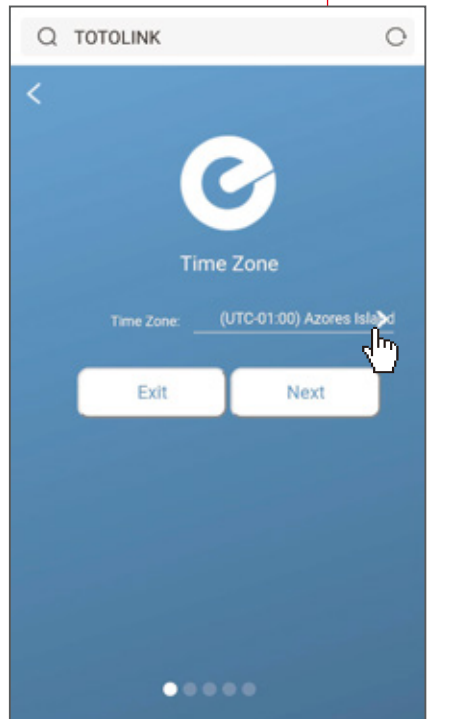

(P3)

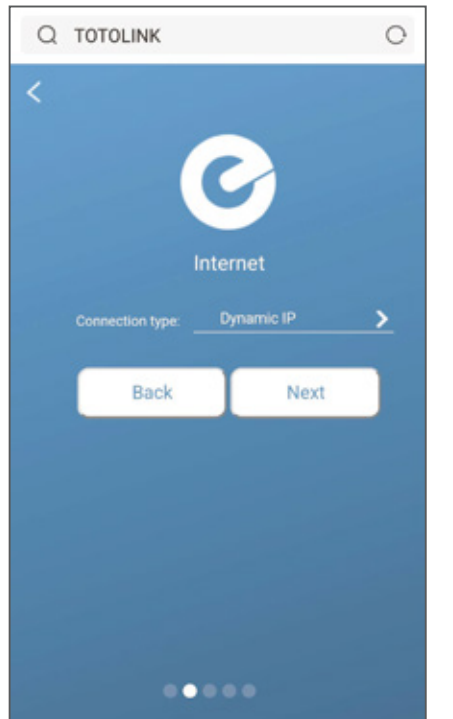

(P4)

2 Configure the Router on Phone

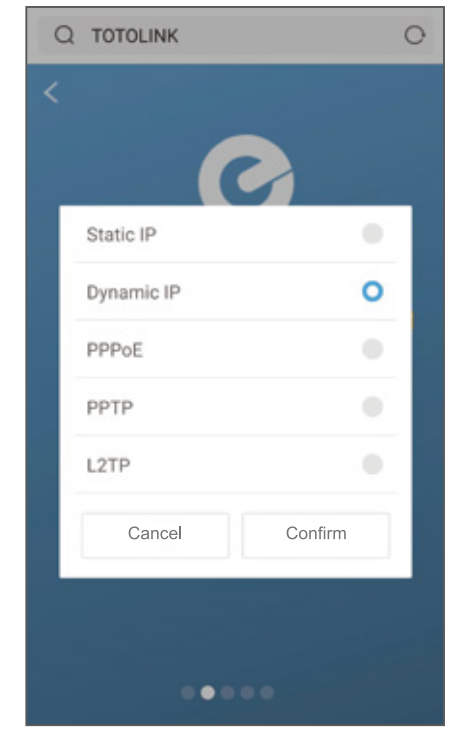

(P5)

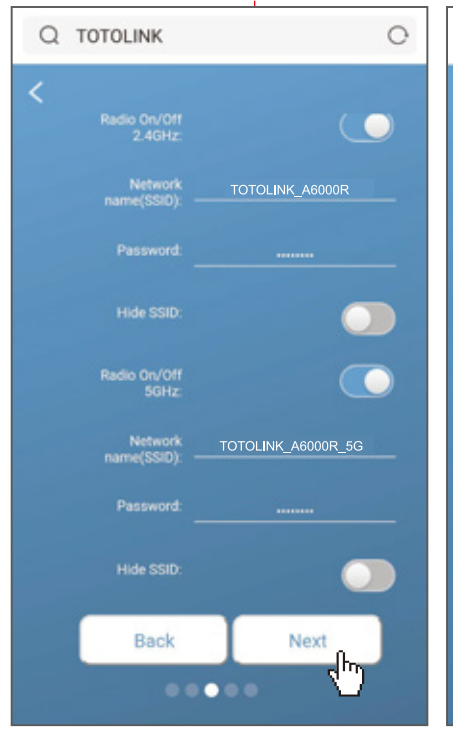

(P7)

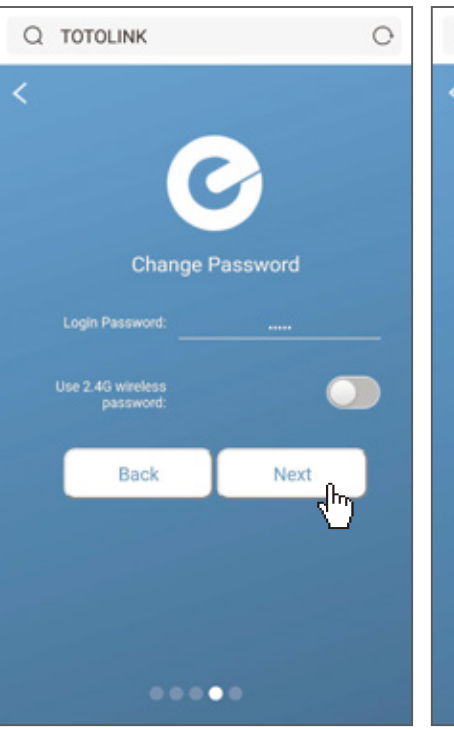

(P8)

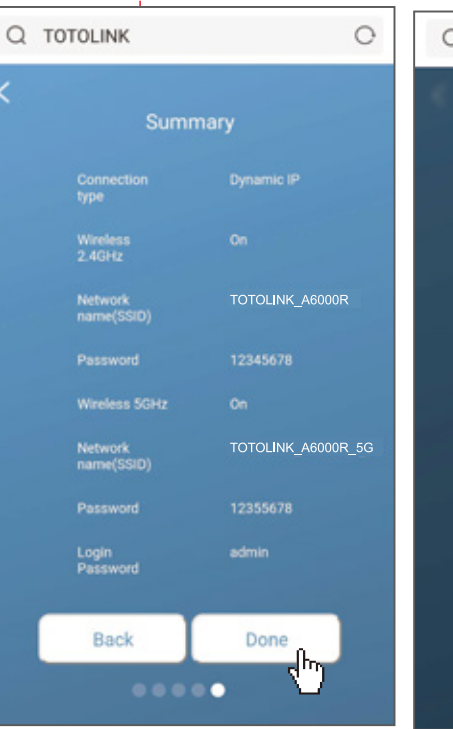

(P9)

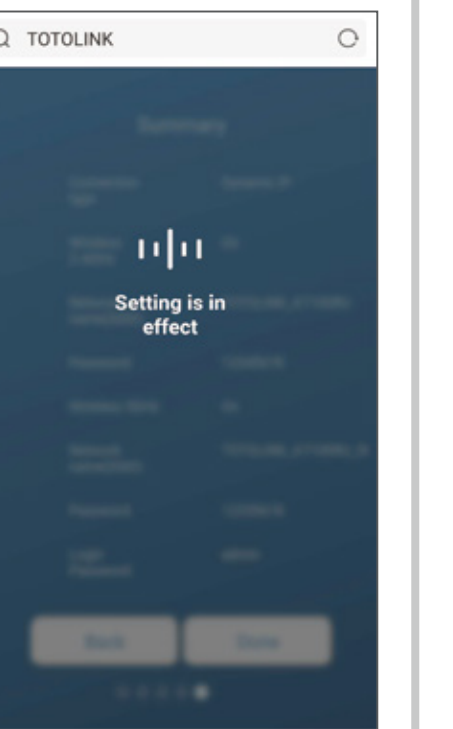

(P10)

Connection Type	Description
Static IP	Input the IP address, Subnet Mask, Default Gateway, DNS from your ISP.
Dynamic IP	No information required. Please confirm with your ISP if Dynamic IP is supported.
PPPoE	Input User Name and Password from your ISP.
PPTP	Input Server Address, User Name and Password from your ISP.
L2TP	Input Server Address, User Name and Password from your ISP.

(P6)

- 5 Wireless Setting. Create passwords for 2.4G and 5G Wi-Fi (Here users could also revise the default Wi-Fi name) and then click **Next**.(P7)
- 6 For security, please create a new Login Password for your router, then click **Next**.(P8)
- 7 The coming page is the Summary information for your setting. Please remember your Wi-Fi Name and Password, then click **Done**.(P9)
- 8 It takes several seconds to save the settings and then your router will restart automatically. This time your Phone will be disconnected from the router. Please back to the WLAN list of your phone to choose the new Wi-Fi name and input the correct password. Now, you could enjoy the Wi-Fi.(P10)

3 FAQs

1. **Unable to log in the router's web page on Phone?**
Please check if your Phone has connected to the Wi-Fi of the router and make sure you have entered the correct default gateway <http://itotolink.net>.
2. **How to reset the router to factory default settings?**
Keep the router powered on, then press and hold the RST/WPS button (for about 5-8 seconds) until System indicator becomes blinking quickly.
3. **How to do if forgetting the router's Login Password?**
Reset the router to its factory settings. The Password would be resumed to **admin**.
4. **How to do if forgetting the password of the Wi-Fi?**
1)Connect any LAN port of the router and then log in the router on computer to check the Wi-Fi password.
2)Reset the router and configure the router again.

FCC warning:
This equipment has been tested and found to comply with the limits for a Class B digital device, pursuant to Part 15 of the FCC Rules. These limits are designed to provide reasonable protection against harmful interference in a residential installation. This equipment generates, uses and can radiate radio frequency energy and, if not installed and used in accordance with the instructions, may cause harmful interference to radio communications. However, there is no guarantee that interference will not occur in a particular installation. If this equipment does cause harmful interference to radio or television reception, which can be determined by turning the equipment off and on, the user is encouraged to try to correct the interference by one or more of the following measures:
- Reorient or relocate the receiving antenna.
- Increase the separation between the equipment and receiver.
- Connect the equipment into an outlet on a circuit different from that to which the receiver is connected.

- Consult the dealer or an experienced radio/TV technician for help.
Operation is subject to the following two conditions:
(1) This device may not cause harmful interference
(2) This device must accept any interference received, including interference that may cause undesired operation.

RF Radiation Exposure Statement
This equipment complies with FCC radiation exposure limits set forth for an uncontrolled environment .
This transmitter must not be co-located or operating in conjunction with any other antenna or transmitter.
This equipment should be installed and operated with minimum distance 20cm between the radiator& your body.